

BONE SCREWS

Mini Screws

Cortical Screw

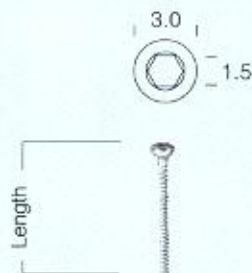

1.5mm

Cortical Screw



2.0mm

Cortical Screw



2.7mm

Length mm	Item Code	Item Code	Item Code
6	020.006	021.006	001.006
7	020.007	021.007	001.007
8	020.008	021.008	001.008
9	020.009	021.009	001.009
10	020.010	021.010	001.010
11	020.011	021.011	001.011
12	020.012	021.012	001.012
14	020.014	021.014	001.014
16	020.016	021.016	001.016
18	020.018	021.018	001.018
20	020.020	021.020	001.020
22			001.022
24			001.024
26			001.026
28			001.028

BONE SCREWS

Small Screws

Cortical Screw



Cortical Screw



Malleolar Screw

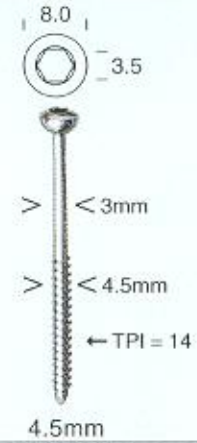

Length mm	Item Code	Item Code	Item Code
10	002.010		
12	002.012	003.012	
14	002.014	003.014	
16	002.016	003.016	
18	002.018	003.018	
20	002.020	003.020	
22	002.022	003.022	
24	002.024	003.024	
25			007.025
26	002.026	003.026	
28	002.028	003.028	
30	002.030	003.030	007.030
32	002.032	003.032	
34	002.034	003.034	
35			007.035
36	002.036	003.036	
38	002.038	003.038	
40	002.040	003.040	007.040
42	002.042	003.042	
44	002.044	003.044	
45			007.045
46	002.046	003.046	
48	002.048	003.048	
50	002.050	003.050	007.050
52		003.052	
54		003.054	
55			007.055
56		003.056	
58		003.058	
60		003.060	007.060
62		003.062	
64		003.064	
65			007.065
66		003.066	
68		003.068	
70		003.070	007.070

BONE SCREWS

Large Screws

Cancellous Screw

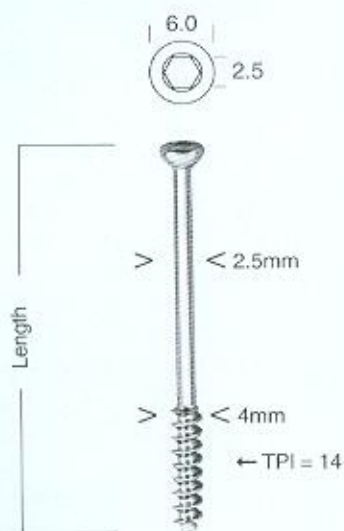

Short Thread
4.0mm

Cancellous Screw



Full Thread
4.0mm

Cancellous Screw



Full Thread
3.5mm

Length mm	Item Code	Item Code	Item Code
10	005.010	006.010	004.010
12	005.012	006.012	004.012
14	005.014	006.014	004.014
16	005.016	006.016	004.016
18	005.018	006.018	004.018
20	005.020	006.020	004.020
22	005.022	006.022	004.022
24	005.024	006.024	004.024
26	005.026	006.026	004.026
28	005.028	006.028	004.028
30	005.030	006.030	007.030
32	005.032	006.032	004.032
34	005.034	006.034	004.034
36	005.036	006.036	004.036
38	005.038	006.038	004.038
40	005.040	006.040	004.040
42	005.042	006.042	004.042
44	005.044	006.044	004.044
46	005.046	006.046	004.046
48	005.048	006.048	004.048
50	005.050	006.050	004.050
52	005.052	006.052	004.052
54	005.054	006.054	004.054
56	005.056	006.056	004.056
58	005.058	006.058	004.058
60	005.060	006.060	004.060

BONE SCREWS

Large Screws

Cancellous Screw



Cancellous Screw



Cancellous Screw



Length mm	Item Code	Item Code	Item Code
25	008.025		010.025
30	008.030		010.030
35	008.035	009.035	010.035
40	008.040	009.040	010.040
45	008.045	009.045	010.045
50	008.050	009.050	010.050
55	008.055	009.055	010.055
60	008.060	009.060	010.060
65	008.065	009.065	010.065
70	008.070	009.070	010.070
75	008.075	009.075	010.075
80	008.080	009.080	010.080
85	008.085	009.085	010.085
90	008.090	009.090	010.090
95	008.095	009.095	010.095
100	008.100	009.100	010.100
105	008.105	009.105	010.105
110	008.110	009.110	010.110

BONE PLATES

Broad Bone Plate, Self Compression

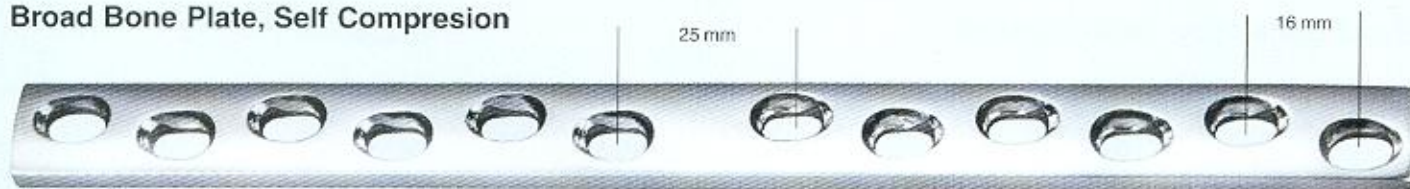

Item Code	No. of Holes	Length mm
058.004	4	71
058.005	5	87
058.006	6	103
058.007	7	119
058.008	8	135
058.009	9	151
058.010	10	167
058.011	11	183
058.012	12	199
058.014	14	231
058.016	16	263
058.018	18	295

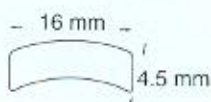

- Fixation with 4.5 & 6.5mm screws.
- All holes are self compressing holes.
- End holes are designed for cancellous screws.

Narrow Bone Plate, Self Compression

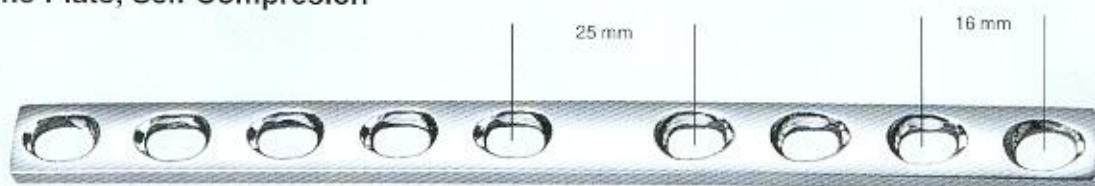

Item Code	No. of Holes	Length mm
057.004	4	71
057.005	5	87
057.006	6	103
057.007	7	119
057.008	8	135
057.009	9	151
057.010	10	167
057.011	11	183
057.012	12	199
057.013	13	215
057.014	14	231
057.015	15	247
057.016	16	263

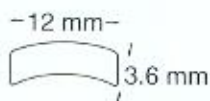

- Fixation with 4.5 & 6.5mm screws.
- All holes are self compressing holes.
- End holes are designed for cancellous screws.

BONE PLATES

Small Bone Plate, Self Compression

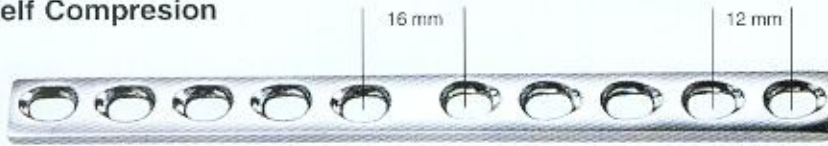

Item Code	No. of Holes	Length mm
040.002	2	25
040.003	3	37
040.004	4	49
040.005	5	61
040.006	6	73
040.007	7	85
040.008	8	97
040.009	9	109
040.010	10	121
040.012	12	145

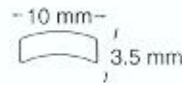

- Fixation with 3.5 & 4.5mm screws.

Cloverleaf Plate

Item Code	No. of Holes	Length mm
046.003	3	88
046.004	4	104
046.005	5	120
046.006	6	136
046.007	7	152
046.008	8	168
046.009	9	184
046.010	10	200

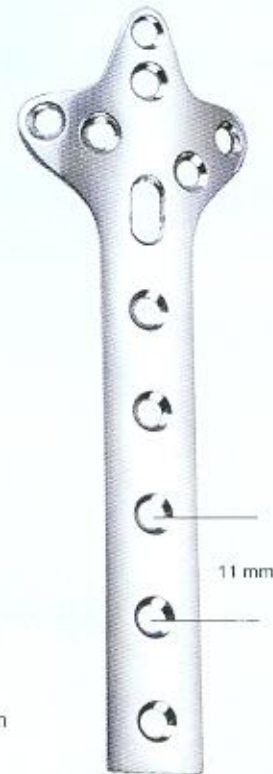
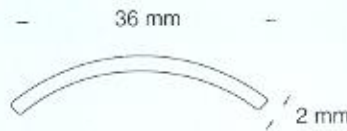

- Fixation with 3.5 & 4.0mm screws.

BONE PLATES

T Plate

Item Code	No. of Holes	Length mm
059.003	3	68
059.004	4	84
059.005	5	100
059.006	6	116
059.007	7	134
059.008	8	148
059.009	9	164

- Fixation with 4.5 & 6.5mm screws.

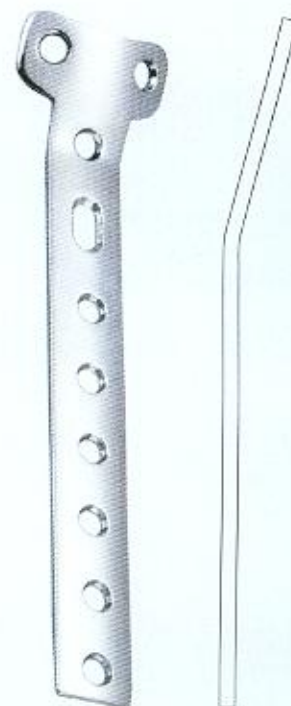
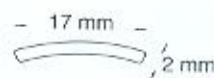
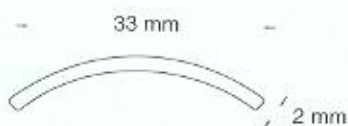

T Buttress Plate

Item Code	No. of Holes	Length mm
060.003	3	68
060.004	4	81
060.005	5	96
060.006	6	112
060.007	7	134
060.008	8	148
060.009	9	164

- Fixation with 4.5 & 6.5mm screws with double bend as buttress for tibial head fractures.

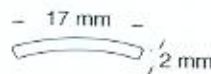
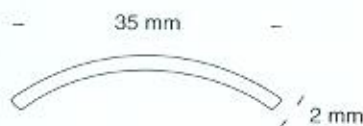



ISO 9001: 2000 CERTIFIED



SINCE : 1948

BONE PLATES

L Buttress Plate

Left

Item Code	No. of Holes	Length mm
062.003	3	69
062.004	4	85
062.005	5	101
062.006	6	119

Right

Item Code	No. of Holes	Length mm
061.003	3	69
061.004	4	85
061.005	5	101
061.006	6	119

- Fixation with 4.5 & 6.5mm screws with double bend as buttress for tibial & humeral head fractures.

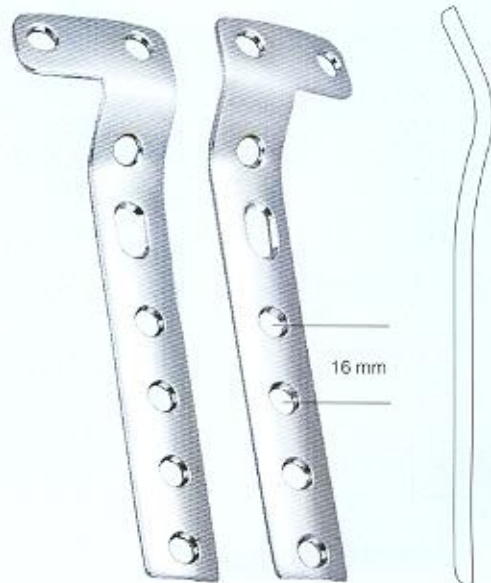
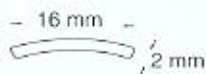
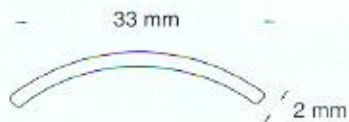

BONE PLATES

Cobra Head Plate

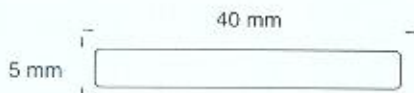

Item Code	No. of Holes	Length mm
085.008	8	170
085.009	9	186
085.010	10	202
085.011	11	218

- Shaft with dynamic compression holes.
- Slot for tension device.

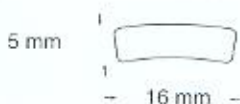

BONE PLATES

Condylar Buttress Plate

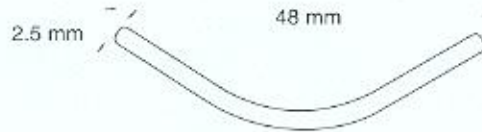

Left

Item Code	No. of Holes
091.007	7
091.009	9
091.011	11
091.012	12
091.013	13
091.015	15

Right

Item Code	No. of Holes
092.007	7
092.009	9
092.011	11
092.012	12
092.013	13
092.015	15

• Fixation with 4.5 & 6.5mm screws.

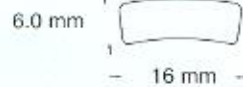
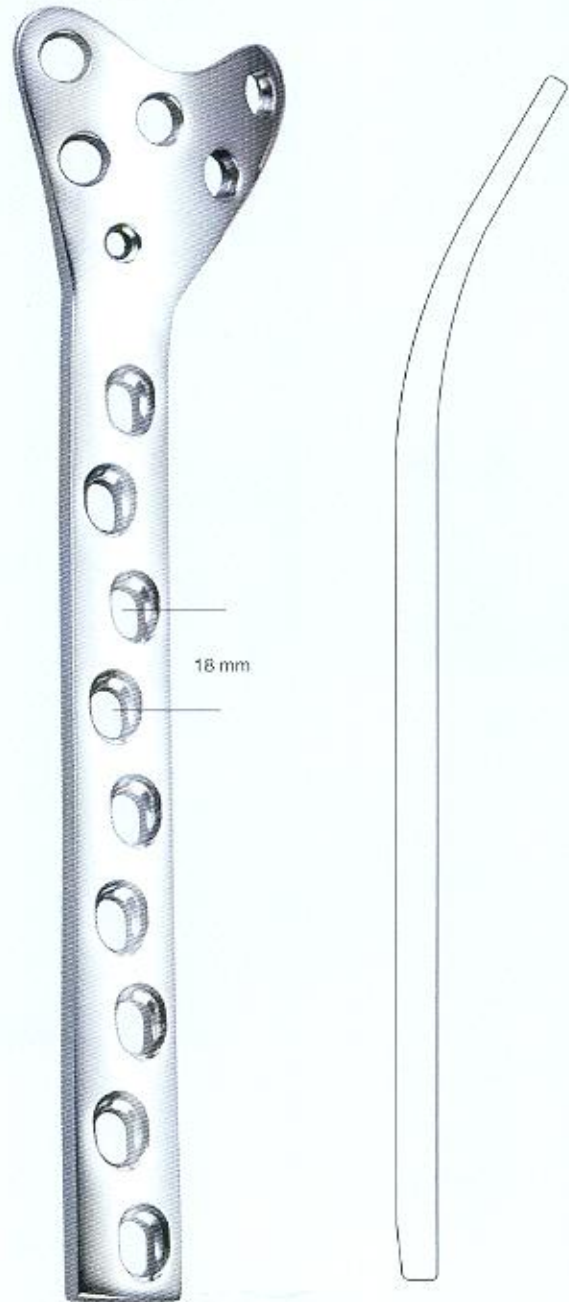

BONE PLATES

One-Third Tubular Plate

Item Code	No. of Holes	Length mm
038.002	2	25
038.003	3	37
038.004	4	49
038.005	5	61
038.006	6	73
038.007	7	85
038.008	8	97
038.009	9	109
038.010	10	121
038.012	12	145

- Fixation with 3.5 & 4.0mm screws.



Semi Tubular Plate

Item Code	No. of Holes	Length mm
056.004	4	71
056.005	5	87
056.006	6	103
056.007	7	119
056.008	8	135
056.009	9	151
056.010	10	167
056.011	11	183
056.012	12	199

- Fixation with 4.5mm screws.



Quarter Tubular Plate

Item Code	No. of Holes	Length mm
031.002	2	15
031.003	3	23
031.004	4	31
031.005	5	39
031.006	6	47
031.007	7	55
031.008	8	63
031.010	10	71

- Fixation with 2.7mm screws.



BONE PLATES

Small T Plate Right Angled

Item Code	No. of Holes	Length mm
041.003	3	39
041.004	4	56
041.005	5	67
041.006	6	78

- Number of holes in head 3
- Fixation with 3.5 & 4.0mm screws.

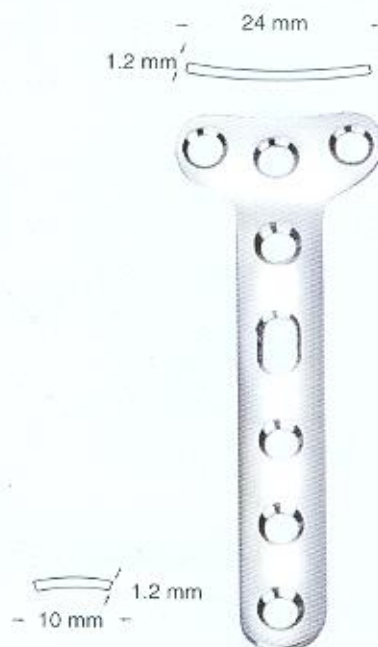

T Plate Oblique Angled

Item Code	No. of Holes
042.003	3
042.004	4
042.005	5
042.006	6

- Number of holes in head 3
- Fixation with 3.5 & 4.0mm screws.



BONE PLATES

Reconstruction Plate

Item Code	No. of Holes	Length mm
044.005	5	58
044.006	6	70
044.007	7	82
044.008	8	94
044.009	9	106
044.010	10	118
044.012	12	142
044.014	14	166
044.016	16	190
044.018	18	214
044.020	20	238
044.022	22	262

- Fixation with 3.5mm screws.



Y Reconstruction Plate

Item Code	Size
045.001	Small
045.002	Large

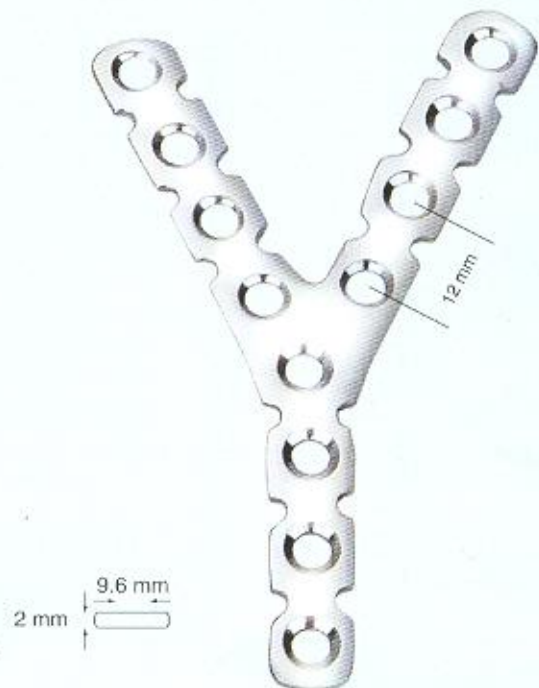

BONE PLATES

Condylar Blade Plate 95°

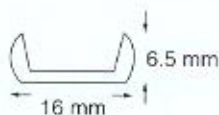

Item Code	No. of Holes	Blade Length mm	Shaft Length mm
063.050	5	50	92
063.060	5	60	92
063.070	5	70	92
063.080	5	80	92
064.050	7	50	124
064.060	7	60	124
064.070	7	70	124
064.080	7	80	124
065.050	9	50	156
065.060	9	60	156
065.070	9	70	156
065.080	9	80	156
066.050	12	50	204
066.060	12	60	204
066.070	12	70	204
066.080	12	80	204
067.050	14	50	236
067.060	14	60	236
067.070	14	70	236
067.080	14	80	236
068.050	16	50	268
068.060	16	60	268
068.070	16	70	268
068.080	16	80	268
069.050	18	50	300
069.060	18	60	300
069.070	18	70	300
069.080	18	80	300

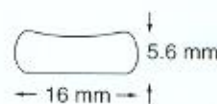
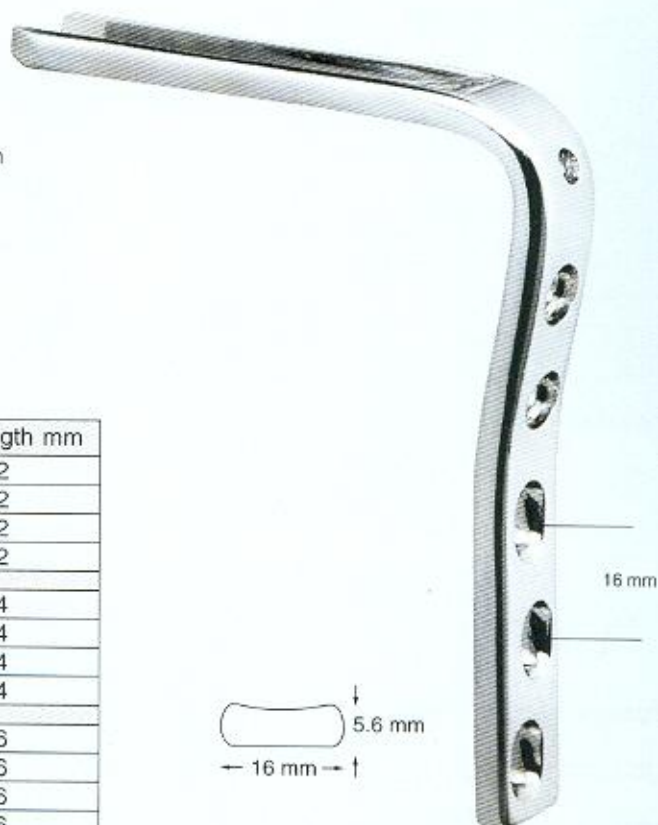

BONE PLATES

DHS Barrel Plate



No. of Holes	130° Item Code	135° Item Code	140° Item Code	145° Item Code	150° Item Code
2	101.002	102.002	103.002	104.002	105.002
3	101.003	102.003	103.003	104.003	105.003
4	101.004	102.004	103.004	104.004	105.004
5	101.005	102.005	103.005	104.005	105.005
6	101.006	102.006	103.006	104.006	105.006
7	101.007	102.007	103.007	104.007	105.007
8	101.008	102.008	103.008	104.008	105.008
9	101.009	102.009	103.009	104.009	105.009
10	101.010	102.010	103.010	104.010	105.010
11	101.011	102.011	103.011	104.011	105.011
12	101.012	102.012	103.012	104.012	105.012
13	101.013	102.013	103.013	104.013	105.013
14	101.014	102.014	103.014	104.014	105.014
15	101.015	102.015	103.015	104.015	105.015
16	101.016	102.016	103.016	104.016	105.016
17	101.017	102.017	103.017	104.017	105.017
18	101.018	102.018	103.018	104.018	105.018

- SHORT BARREL size 25mm ALSO AVAILABLE.
- Round holes available on request.

Fixation with 4.5mm cortical screws.
With dynamic compression holes

LAG SCREW

DHS / DCS LAG Screw Dia. 12.5mm

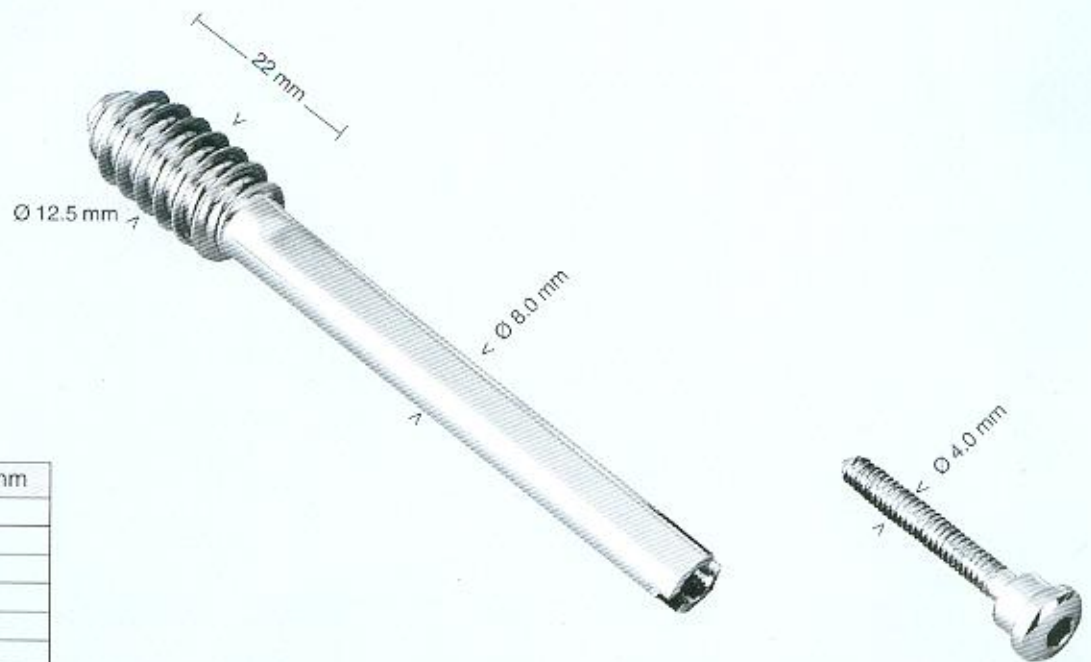

Item Code	Length mm
108.050	50
108.055	55
108.060	60
108.065	65
108.070	70
108.075	75
108.080	80
108.085	85
108.090	90
108.095	95
108.100	100
108.105	105
108.110	110
108.115	115
108.120	120
108.125	125
108.130	130
108.135	135
108.140	140
108.145	145

- Compression screw with hexagonal socket for hexagonal screw driver.

BONE PLATES

DCS Plate 95°

Item Code	No. of Holes
107.006	6
107.007	7
107.008	8
107.009	9
107.010	10
107.012	12
107.014	14
107.016	16
107.018	18
107.020	20
107.022	22

- With dynamic compression holes fixation with 4.5mm cortical screws.

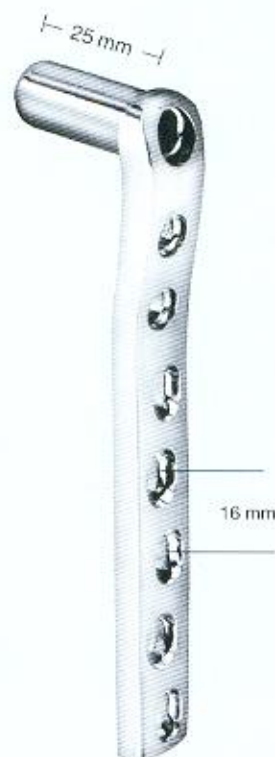
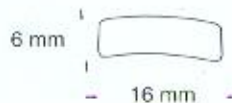

LC DCP (Low Contact Dynamic Compression Plate)



BROAD

Item Code	No. of Holes
051.004	4
051.005	5
051.006	6
051.007	7
051.008	8
051.009	9
051.010	10
051.011	11
051.012	12
051.013	13
051.014	14
051.015	15
051.016	16
051.017	17
051.018	18

NARROW

Item Code	No. of Holes
050.004	4
050.005	5
050.006	6
050.007	7
050.008	8
050.009	9
050.010	10
050.011	11
050.012	12
050.014	14
050.016	16

SMALL

Item Code	No. of Holes
047.004	4
047.005	5
047.006	6
047.007	7
047.008	8
047.009	9
047.010	10
047.011	11
047.012	12

MINI BONE PLATES

Mini Plates

L Plate 2.7mm

Item Code	
033.001	Left
033.002	Right



Mini T Plate for 2.7 mm Screw

Item Code
034.001

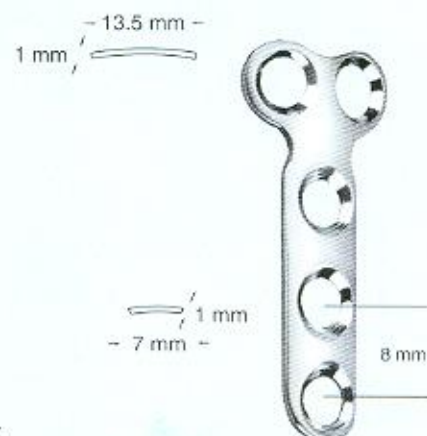

MINI BONE PLATES

Mini Straight Plate

Item Code	No. of Holes	Length mm
022.002	2	11
022.003	3	17
022.004	4	23
022.005	5	29
022.006	6	35
022.007	7	41
022.008	8	47



2.7mm DCP Plate

Item Code	No. of Holes	Length mm
032.002	2	20
032.003	3	28
032.004	4	36
032.005	5	44
032.006	6	52
032.007	7	60
032.008	8	68
032.009	9	76
032.010	10	84
032.012	12	100



HIP PROSTHESIS

Austin Moore Prosthesis Standard Regular Finish

Item Code	Head Dia mm
117.037	37
117.038	38
117.039	39
117.040	40
117.041	41
117.042	42
117.043	43
117.044	44
117.045	45
117.046	46
117.047	47
117.048	48
117.049	49
117.050	50
117.051	51
117.052	52
117.053	53
117.054	54
117.055	55



Austin Moore Prosthesis Standard Satin Finish

Item Code	Head Dia mm
117.137	37
117.138	38
117.139	39
117.140	40
117.141	41
117.142	42
117.143	43
117.144	44
117.145	45
117.146	46
117.147	47
117.148	48
117.149	49
117.150	50
117.151	51
117.152	52
117.153	53
117.154	54
117.155	55



- Narrow Stem available on request.
- Gamma sterilization can be done on request.

HIP PROSTHESIS

Austin Moore Prosthesis With Slot Regular Finish

Item Code	Head Dia mm
118.037	37
118.038	38
118.039	39
118.040	40
118.041	41
118.042	42
118.043	43
118.044	44
118.045	45
118.046	46
118.047	47
118.048	48
118.049	49
118.050	50
118.051	51
118.052	52
118.053	53
118.054	54
118.055	55



Austin Moore Prosthesis with Slot Satin Finish

Item Code	Head Dia mm
118.137	37
118.138	38
118.139	39
118.140	40
118.141	41
118.142	42
118.143	43
118.144	44
118.145	45
118.146	46
118.147	47
118.148	48
118.149	49
118.150	50
118.151	51
118.152	52
118.153	53
118.154	54
118.155	55



- Narrow Stem available on request.
- Gamma sterilization can be done on request.

HIP PROSTHESIS

Austin Moore Prosthesis With Modified Slot Satin Finish

Item Code	Head Dia mm
118M.137	37
118M.138	38
118M.139	39
118M.140	40
118M.141	41
118M.142	42
118M.143	43
118M.144	44
118M.145	45
118M.146	46
118M.147	47
118M.148	48
118M.149	49
118M.150	50
118M.151	51
118M.152	52
118M.153	53
118M.154	54
118M.155	55



Austin Moore Prosthesis With Modified Slot & Step Head Satin Finish

Item Code	Head Dia mm
118MS.137	37
118MS.138	38
118MS.139	39
118MS.140	40
118MS.141	41
118MS.142	42
118MS.143	43
118MS.144	44
118MS.145	45
118MS.146	46
118MS.147	47
118MS.148	48
118MS.149	49
118MS.150	50
118MS.151	51
118MS.152	52
118MS.153	53
118MS.154	54
118MS.155	55



• Gamma sterilization can be done on request.

HIP PROSTHESIS

Austin Moore Prosthesis, Standard, Step Head Satin Finish

Item Code	Head Dia mm
119.137	37
119.138	38
119.139	39
119.140	40
119.141	41
119.142	42
119.143	43
119.144	44
119.145	45
119.146	46
119.147	47
119.148	48
119.149	49
119.150	50
119.151	51
119.152	52
119.153	53
119.154	54
119.155	55



Austin Moore Prosthesis Long Stem Regular Finish

Item Code	Head Dia mm
121.037	37
121.038	38
121.039	39
121.040	40
121.041	41
121.042	42
121.043	43
121.044	44
121.045	45
121.046	46
121.047	47
121.048	48
121.049	49
121.050	50
121.051	51
121.052	52
121.053	53
121.054	54
121.055	55



• Gamma sterilization can be done on request.

HIP PROSTHESIS

Thompson Hip Prosthesis, Standard Regular Finish

Item Code	Head Dia mm
116.037	37
116.038	38
116.039	39
116.040	40
116.041	41
116.042	42
116.043	43
116.044	44
116.045	45
116.046	46
116.047	47
116.048	48
116.049	49
116.050	50
116.051	51
116.052	52
116.053	53
116.054	54
116.055	55



Thompson Hip Prosthesis, Standard Satin Finish

Item Code	Head Dia mm
116.137	37
116.138	38
116.139	39
116.140	40
116.141	41
116.142	42
116.143	43
116.144	44
116.145	45
116.146	46
116.147	47
116.148	48
116.149	49
116.150	50
116.151	51
116.152	52
116.153	53
116.154	54
116.155	55



• Gamma sterilization can be done on request.

HIP PROSTHESIS

Thompson Hip Prosthesis with Collar Regular Finish

Item Code	Head Dia mm
115.037	37
115.038	38
115.039	39
115.040	40
115.041	41
115.042	42
115.043	43
115.044	44
115.045	45
115.046	46
115.047	47
115.048	48
115.049	49
115.050	50
115.051	51
115.052	52
115.053	53
115.054	54
115.055	55



Thompson Hip Prosthesis with Collar Satin Finish

Item Code	Head Dia mm
115.137	37
115.138	38
115.139	39
115.140	40
115.141	41
115.142	42
115.143	43
115.144	44
115.145	45
115.146	46
115.147	47
115.148	48
115.149	49
115.150	50
115.151	51
115.152	52
115.153	53
115.154	54
115.155	55



• Gamma sterilization can be done on request.

HIP PROSTHESIS

Thompson Hip Prosthesis Standard Stem, Modified Collar Satin Finish

Item Code	Head Dia mm
115MS.137	37
115MS.138	38
115MS.139	39
115MS.140	40
115MS.141	41
115MS.142	42
115MS.143	43
115MS.144	44
115MS.145	45
115MS.146	46
115MS.147	47
115MS.148	48
115MS.149	49
115MS.150	50
115MS.151	51
115MS.152	52
115MS.153	53
115MS.154	54
115MS.155	55



Thompson Hip Prosthesis Narrow Stem, Modified Collar Satin Finish

Item Code	Head Dia mm
115MN.137	37
115MN.138	36
115MN.139	39
115MN.140	40
115MN.141	41
115MN.142	42
115MN.143	43
115MN.144	44
115MN.145	45
115MN.146	46
115MN.147	47
115MN.148	48
115MN.149	49
115MN.150	50
115MN.151	51
115MN.152	52
115MN.153	53
115MN.154	54
115MN.155	55



• Gamma sterilization can be done on request.

NAILS

Kuntscher Clover Leaf — Nails, Femur

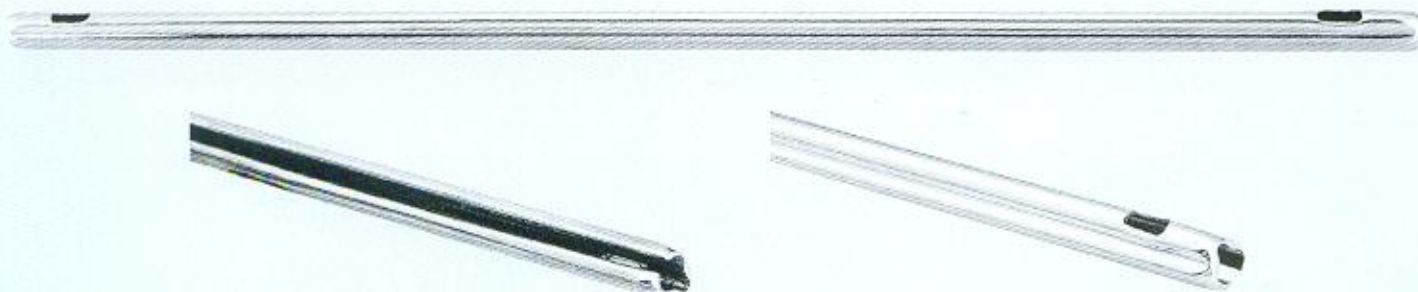

Dia. mm Length (cms)	ø 6	ø 7	ø 8	ø 9	ø 10	ø 11	ø 12	ø 13	ø 14	ø 15
20	134.0620	134.0720	134.0820	134.0920	134.1020	134.1120	134.1220	134.1320	134.1420	134.1520
22	134.0622	134.0722	134.0822	134.0922	134.1022	134.1122	134.1222	134.1322	134.1422	134.1522
24	134.0624	134.0724	134.0824	134.0924	134.1024	134.1124	134.1224	134.1324	134.1424	134.1524
26	134.0626	134.0726	134.0826	134.0926	134.1026	134.1126	134.1226	134.1326	134.1426	134.1526
28	134.0628	134.0728	134.0828	134.0928	134.1028	134.1128	134.1228	134.1328	134.1428	134.1528
30	134.0630	134.0730	134.0830	134.0930	134.1030	134.1130	134.1230	134.1330	134.1430	134.1530
32	134.0632	134.0732	134.0832	134.0932	134.1032	134.1132	134.1232	134.1332	134.1432	134.1532
34	134.0634	134.0734	134.0834	134.0934	134.1034	134.1134	134.1234	134.1334	134.1434	134.1534
36	134.0636	134.0736	134.0836	134.0936	134.1036	134.1136	134.1236	134.1336	134.1436	134.1536
38	134.0638	134.0738	134.0838	134.0938	134.1038	134.1138	134.1238	134.1338	134.1438	134.1538
40	134.0640	134.0740	134.0840	134.0940	134.1040	134.1140	134.1240	134.1340	134.1440	134.1540
42	134.0642	134.0742	134.0842	134.0942	134.1042	134.1142	134.1242	134.1342	134.1442	134.1542
44	134.0644	134.0744	134.0844	134.0944	134.1044	134.1144	134.1244	134.1344	134.1444	134.1544
46	134.0646	134.0746	134.0846	134.0946	134.1046	134.1146	134.1246	134.1346	134.1446	134.1546
48	134.0648	134.0748	134.0848	134.0948	134.1048	134.1148	134.1248	134.1348	134.1448	134.1548

- Available in any length on request.

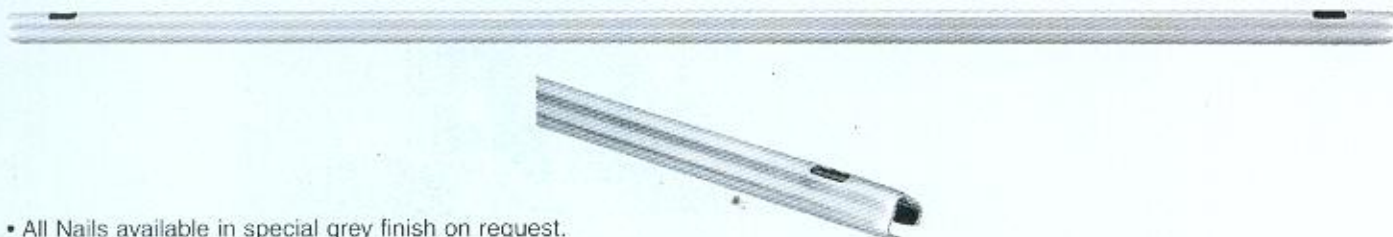

- All Nails available in special grey finish on request.

NAILS

Kuntscher Clover Leaf — Nails, Tibia

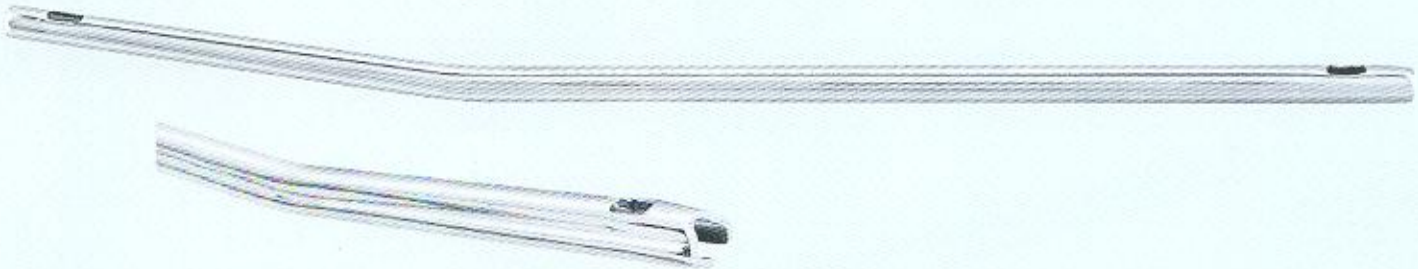

Length (cms) \ Dia. mm	ø 7	ø 8	ø 9	ø 10
26	135.0726	135.0826	135.0926	135.1026
28	135.0728	135.0828	135.0928	135.1028
30	135.0730	135.0830	135.0930	135.1030
32	135.0732	135.0832	135.0932	135.1032
34	135.0734	135.0834	135.0934	135.1034
36	135.0736	135.0836	135.0936	135.1036
38	135.0738	135.0838	135.0938	135.1038
40	135.0740	135.0840	135.0940	135.1040
42	135.0742	135.0842	135.0942	135.1042
44	135.0744	135.0844	135.0944	135.1044

- Available in any length on request.

Kuntscher Clover Leaf — Nails, Tibia Short Bend.



Length (cms) \ Dia. mm	ø 7	ø 8	ø 9	ø 10
26	S135.0726	S135.0826	S135.0926	S135.1026
28	S135.0728	S135.0828	S135.0928	S135.1028
30	S135.0730	S135.0830	S135.0930	S135.1030
32	S135.0732	S135.0832	S135.0932	S135.1032
34	S135.0734	S135.0834	S135.0934	S135.1034
36	S135.0736	S135.0836	S135.0936	S135.1036
38	S135.0738	S135.0838	S135.0938	S135.1038
40	S135.0740	S135.0840	S135.0940	S135.1040
42	S135.0742	S135.0842	S135.0942	S135.1042
44	S135.0744	S135.0844	S135.0944	S135.1044

- Grey Finish Available.
- Available in any length on request.

NAILS

Kuntscher Clover Leaf — Nails, Tibia Double Bend.

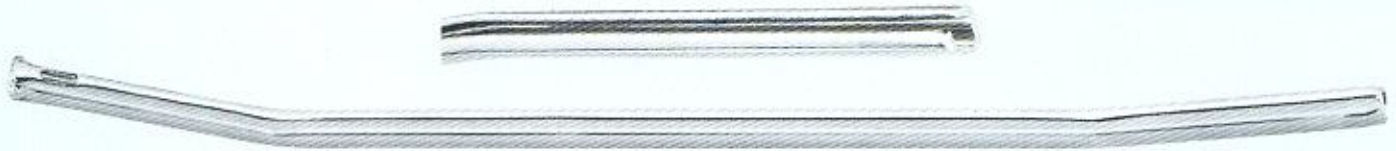

Dia. mm Length (cms)	ø 7	ø 8	ø 9	ø 10
26	D135.0726	D135.0826	D135.0926	D135.1026
28	D135.0728	D135.0828	D135.0928	D135.1028
30	D135.0730	D135.0830	D135.0930	D135.1030
32	D135.0732	D135.0832	D135.0932	D135.1032
34	D135.0734	D135.0834	D135.0934	D135.1034
36	D135.0736	D135.0836	D135.0936	D135.1036
38	D135.0738	D135.0838	D135.0938	D135.1038
40	D135.0740	D135.0840	D135.0940	D135.1040
42	D135.0742	D135.0842	D135.0942	D135.1042
44	D135.0744	D135.0844	D135.0944	D135.1044

• Available in any length on request

Rush Nails



Dia. mm Length (cms)	ø 2.0	ø 2.5	ø 3.0	ø 3.5	ø 4.0	ø 5.0	ø 6.0
10	140.2010	140.2510	140.3010	140.3510	140.4010	140.5010	140.6010
12	140.2012	140.2512	140.3012	140.3512	140.4012	140.5010	140.6012
14	140.2014	140.2514	140.3014	140.3514	140.3514	140.5014	140.6014
16	140.2016	140.2516	140.3016	140.3516	140.4016	140.5016	140.6016
18	140.2018	140.2518	140.3018	140.3518	140.4018	140.5018	140.6018
20	140.2020	140.2520	140.3020	140.3520	140.4020	140.5020	140.6020
22	140.2022	140.2522	140.3022	140.3522	140.4022	140.5022	140.6022
24	140.2024	140.2524	140.3024	140.3524	140.4024	140.5024	140.6024
26	140.2026	140.2526	140.3026	140.3526	140.4026	140.5026	140.6026
28	140.2028	140.2528	140.3028	140.3528	140.4028	140.5028	140.6028
30	140.2030	140.2530	140.3030	140.3530	140.4030	140.5030	140.6030
32	140.2032	140.2532	140.3032	140.3532	140.4032	140.5032	140.6032
34	140.2034	140.2534	140.3034	140.3534	140.4034	140.5034	140.6034
36	140.2036	140.2536	140.3036	140.3536	140.4036	140.5036	140.6036
38	140.2038	140.2538	140.3038	140.3538	140.4038	140.5038	140.6038
40	140.2040	140.2540	140.3040	140.3540	140.4040	140.5040	140.6040

• Available in any length on request

NAILS

Inter Locking Nails Reamed Femoral Nails

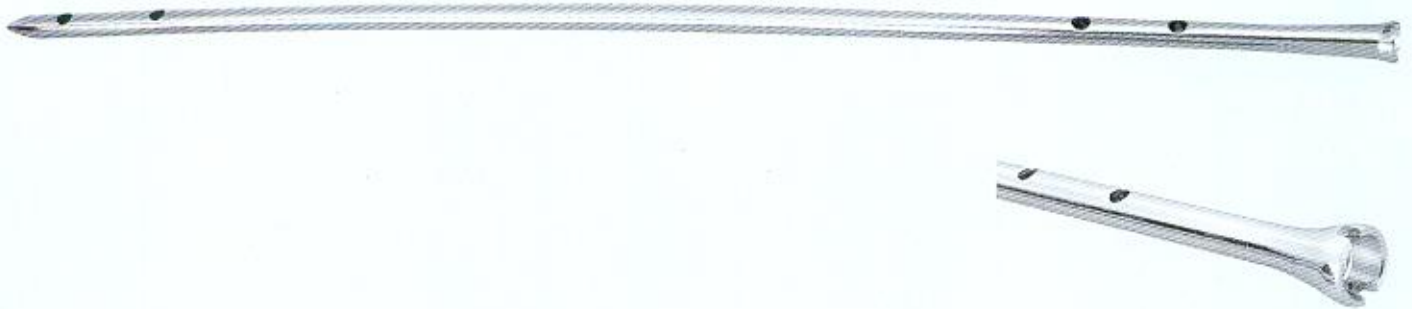

Length (cms) \ Dia. mm	ø 8	ø 9	ø 10	ø 11	ø 12	ø 13
32	FR 08.32	FR 09.32	FR 10.32	FR 09.32	FR 12.32	FR 13.32
34	FR 08.34	FR 09.34	FR 10.34	FR 11.34	FR 12.34	FR 13.34
36	FR 08.36	FR 09.36	FR 10.36	FR 11.36	FR 12.36	FR 13.36
38	FR 08.38	FR 09.38	FR 10.38	FR 11.38	FR 12.38	FR 13.38
40	FR 08.40	FR 09.40	FR 10.40	FR 11.40	FR 12.40	FR 13.40
42	FR 08.42	FR 09.42	FR 10.42	FR 11.42	FR 12.42	FR 13.42
44	FR 08.44	FR 09.44	FR 10.44	FR 11.44	FR 12.44	FR 13.44
46	FR 08.46	FR 09.46	FR 10.46	FR 10.46	FR 12.46	FR 13.46

Unreamed Femoral Nails

Length (cms) \ Dia. mm	ø 9	ø 10	ø 11
32	FU 09.32	FU 10.32	FU 11.32
34	FU 09.34	FU 10.34	FU 11.34
36	FU 09.36	FU 10.36	FU 11.36
38	FU 09.38	FU 10.38	FU 11.38
40	FU 09.40	FU 10.40	FU 11.40
42	FU 09.42	FU 10.42	FU 11.42
44	FU 09.44	FU 10.44	FU 11.44
46	FU 09.46	FU 10.46	FU 11.46

NAILS

Interlocking Nails Reamed Tibial Nail

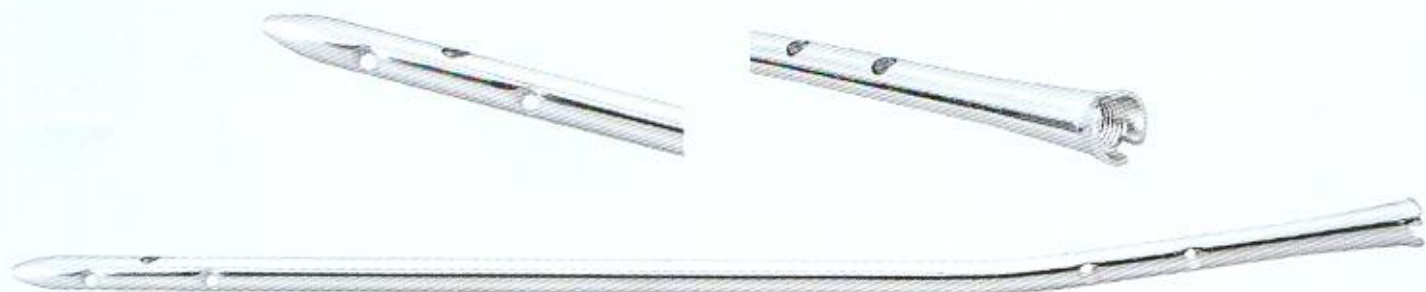

Length (cms) \ Dia. mm	ø 8	ø 9	ø 10	ø 11	ø 12
24	TR 08.24	TR 09.24	TR 10.24	TR 11.24	TR 12.24
26	TR 08.26	TR 09.26	TR 10.26	TR 11.26	TR 12.26
28	TR 08.28	TR 09.28	TR 10.28	TR 11.28	TR 12.28
30	TR 08.30	TR 09.30	TR 10.30	TR 11.30	TR 12.30
32	TR 08.32	TR 09.32	TR 10.32	TR 11.32	TR 12.32
34	TR 08.34	TR 09.34	TR 10.34	TR 11.34	TR 12.34
36	TR 08.36	TR 09.36	TR 10.36	TR 11.36	TR 12.36
38	TR 08.38	TR 09.38	TR 10.38	TR 11.38	TR 12.38
40	TR 08.40	TR 09.40	TR 10.40	TR 11.40	TR 12.40
42	TR 08.42	TR 09.42	TR 10.42	TR 11.42	TR 12.42

Unreamed Tibial Nail

Length (cms) \ Dia. mm	ø 7	ø 8	ø 9	ø 10
26	TU 07.26	TU 08.26	TU 09.26	TU 10.26
28	TU 07.28	TU 08.28	TU 09.28	TU 10.28
30	TU 07.30	TU 08.30	TU 09.30	TU 10.30
32	TU 07.32	TU 08.32	TU 09.32	TU 10.32
34	TU 07.34	TU 08.34	TU 09.34	TU 10.34
36	TU 07.36	TU 08.36	TU 09.36	TU 10.36
38	TU 07.38	TU 08.38	TU 09.38	TU 10.38
40	TU 07.40	TU 08.40	TU 09.40	TU 10.40

PINS

Steinman Pin



Dia. mm \ Length (mm)	3.0	3.5	4.0	4.5	5.0
150	141.30150	141.35150	141.40150	141.45150	141.50150
175	141.30175	141.35175	141.40175	141.45175	141.50175
200	141.30200	141.35200	141.40200	141.45200	141.50200
225	141.30225	141.35225	141.40225	141.45225	141.50225

Steinman Pin Centrally Threaded



Dia. mm \ Length (mm)	3.0	3.5	4.0	4.5	5.0	6.0
225	142.30225	142.35225	142.40225	142.45225	142.50225	142.60225

Kirschner wire (K. Wire)



With Trocar Point on each end

Dia. mm \ Length(mm)	100 mm	130 mm	150 mm	230 mm	300 mm
1.0	138.01100	138.01130	138.01150	138.01230	138.01300
1.2	138.12100	138.12130	138.12150	138.12230	138.12300
1.5	138.15100	138.15130	138.15150	138.15230	138.15300
1.6	138.16100	138.16130	138.16150	138.16230	138.16300
1.8	138.18100	138.18130	138.18150	138.18230	138.18300
2.0	138.20100	138.20130	138.20150	138.20230	138.20300
2.3	138.23100	138.23130	138.23150	138.23230	138.23300
2.5	138.25100	138.25130	138.25150	138.25230	138.25300
3.0	138.30100	138.30130	138.30150	138.30230	138.30300

- Kirschner wire one point round and one point trocar available on request.

PINS

SHANZ SCREW

Dia. mm	Item Code	Total Length/Thread Length mm
ø 4.0	169.001	125/18
ø 4.0	169.002	175/25
ø 4.5	169.003	150/18
ø 4.5	169.004	150/25
ø 4.5	169.005	175/18
ø 4.5	169.006	175/25
ø 4.5	169.007	175/32
ø 4.5	169.008	175/40
ø 4.5	169.009	200/25
ø 4.5	169.010	200/32
ø 4.5	169.011	200/40
ø 4.5	169.012	225/25
ø 4.5	169.013	225/32
ø 4.5	169.014	225/40
ø 5.0	169.015	150/18
ø 5.0	169.016	150/25
ø 5.0	169.017	175/18
ø 5.0	169.018	175/25
ø 5.0	169.019	175/32
ø 5.0	169.020	175/40
ø 5.0	169.021	200/25
ø 5.0	169.022	200/32
ø 5.0	169.023	200/40
ø 5.0	169.024	225/25
ø 5.0	169.025	225/32
ø 5.0	169.026	225/40



DRILL BITS

Drill Bit Quick Coupling End

Dia. mm \ Length mm	100	115	125	130	200
2.0	226.001	----	----	----	----
2.5	----	226.002	----	----	----
2.7	----	----	226.003	----	----
3.2	----	----	----	226.004	226.005
3.5	----	----	----	226.006	226.007
4.5	----	----	----	226.008	226.009



Drill Bit - Plain Shank, Jacob Chuck End

Dia. mm \ Length mm	126	200
1.1	227.001	-----
1.5	227.002	-----
2.0	227.003	-----
2.5	227.004	-----
2.7	227.005	-----
3.2	227.006	227.007
3.5	227.008	227.009
4.5	227.010	227.011



DRILL BITS

Drill Bit Quick Coupling End

Dia. mm \ Length mm	100	115	125	130	200
2.0	226.001	----	----	----	----
2.5	----	226.002	----	----	----
2.7	----	----	226.003	----	----
3.2	----	----	----	226.004	226.005
3.5	----	----	----	226.006	226.007
4.5	----	----	----	226.008	226.009



Drill Bit - Plain Shank, Jacob Chuck End

Dia. mm \ Length mm	126	200
1.1	227.001	-----
1.5	227.002	-----
2.0	227.003	-----
2.5	227.004	-----
2.7	227.005	-----
3.2	227.006	227.007
3.5	227.008	227.009
4.5	227.010	227.011



BONE TAPS

Bone Taps

Dia. mm	Bone Tap with T handle	BoneTap Quick Coupling End
1.5	229.001	230.001
2.0	229.002	230.002
2.7	229.003	230.003
3.5	229.004	230.004
3.5 Cancellous	229.005	230.005
3.5 Extra Long	229.006	230.006
4.5	229.007	230.007
4.5 Extra Long	229.008	230.008
6.5 Cancellous	229.009	230.009

Quick Coupling End



With T Handle



Screw Driver

- Available in various sizes



With holding sleeve



INSTRUMENTS

Bone Awl

Fibre Handle



Stainless Steel



Universal Hand Drill

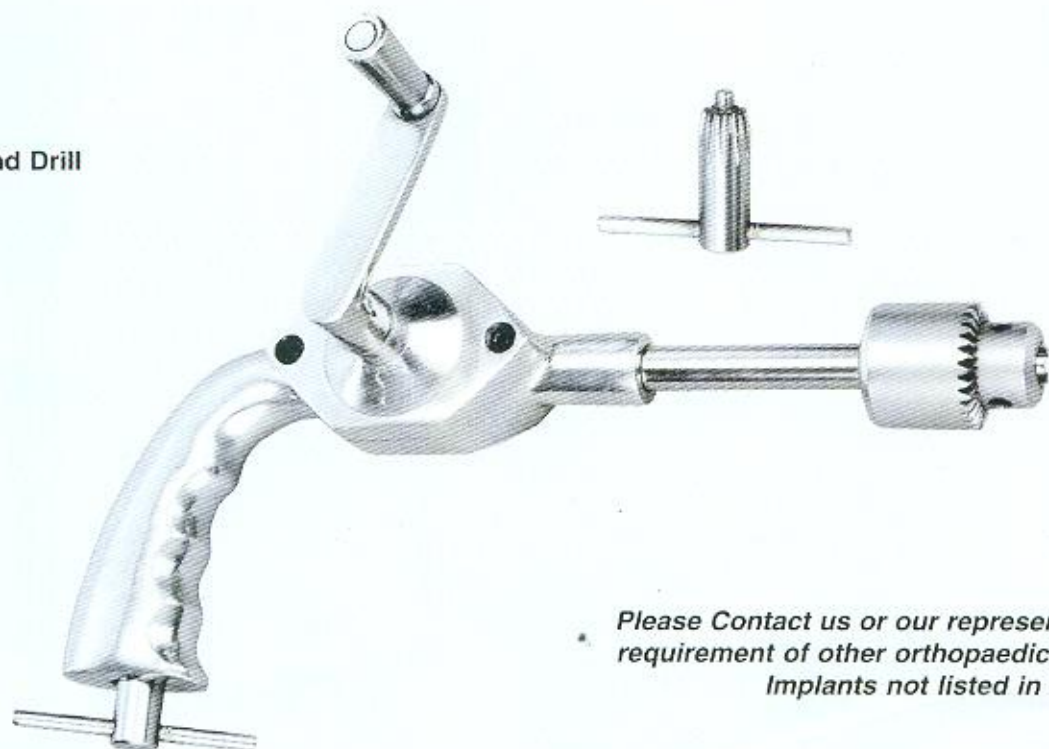

Please Contact us or our representative for your requirement of other orthopaedic Instruments & Implants not listed in this catalogue.